

5G, WLAN, and LTE Wireless Design with MATLAB

Marc Barberis – Application Engineering Group

Agenda

- The 5G Landscape
- Designing 5G Systems
 - Generating waveforms
 - Designing baseband algorithms
 - Propagation channels and interference
 - Antennas and antenna arrays
 - Beamforming
 - RF impairments
- Summary

5G Vision and Use Cases

Not just mobile phones

- To do all of this, 5G will require:
- New physical layer architecture
 - New radio (RF) architecture
 - New network architecture
 - New design and testing approaches

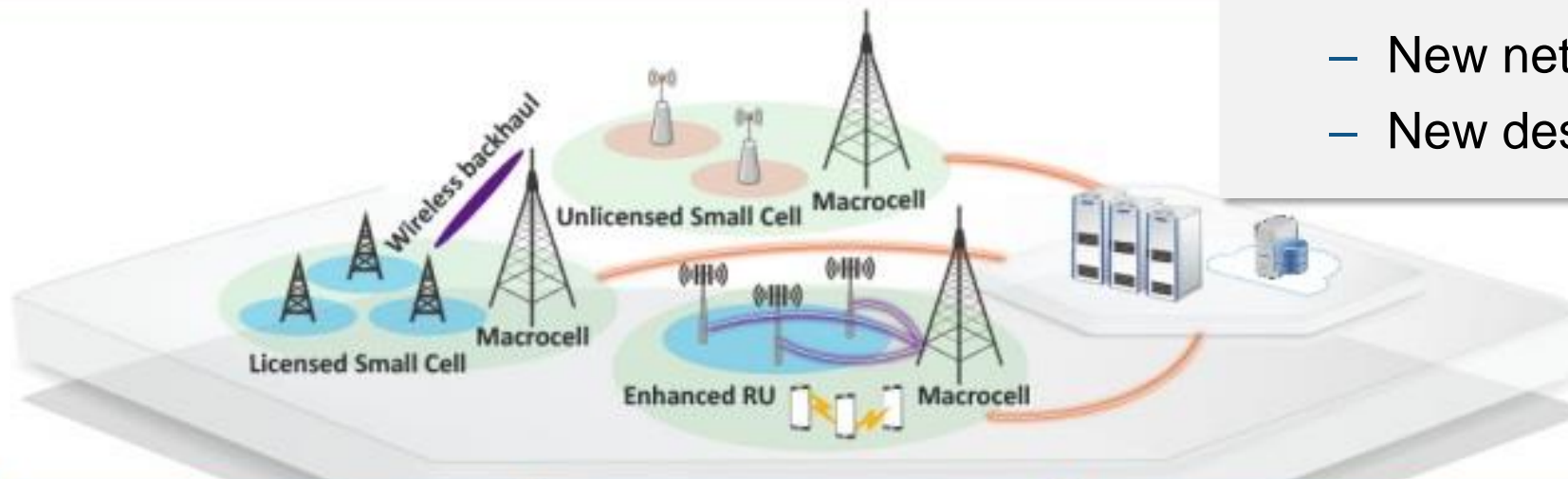

Massive Machine-type Communications		Ultra Reliable & Low Latency		Enhanced Mobile Broadband	
IoT		V2X		Ultra-Fast Mobile	

Standardization Efforts



IEEE 802.11 WLAN standards



802.11ax

Flexible Numerology

802.11ay

3D Channel Models

FD-MIMO



Verizon5G

Hybrid Beamforming

Cellular V2X

mmWave

F-OFDM
W-OFDM

Sidelink / D2D

NB-IoT

Cellular V2X

Polar Codes

Wideband Signals

Cat-M

Hybrid Beamforming

LDPC Codes

Addressing Wireless Engineering Challenges

Standard compliance

- Generate all physical channels and signals

Baseband DSP development

- DSP challenges due to large bandwidths
- Is my implementation correct?
- How can I evaluate link performance with my algorithm?

Antenna array design and evaluation

- Element coupling
- Edge effects
- Imperfections

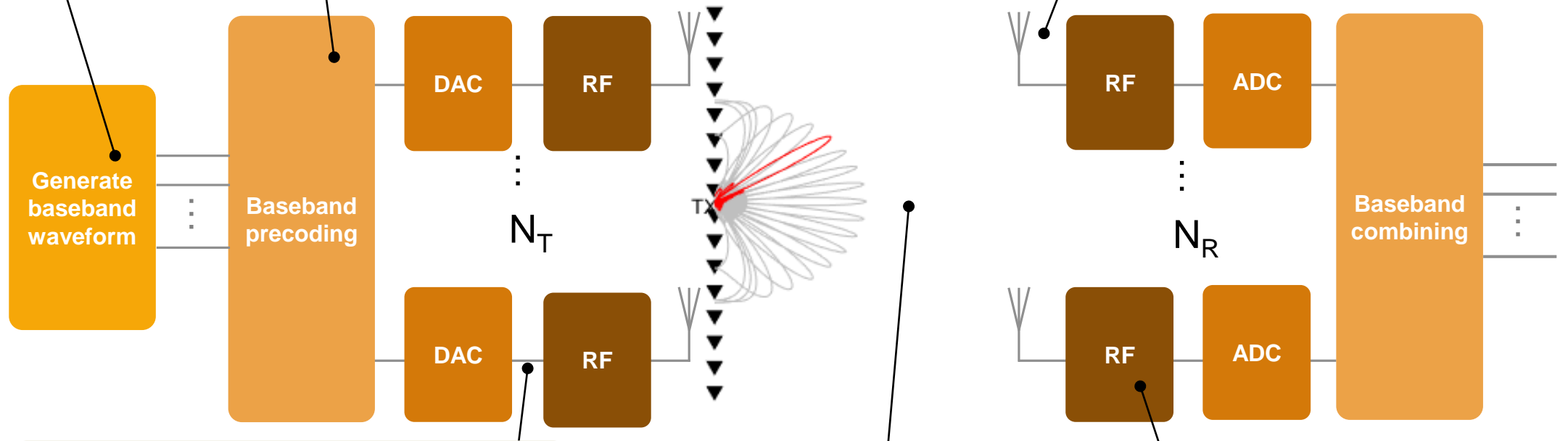

Explore beamforming trade-offs

- Baseband, analog or hybrid beamforming?
- Simulate capabilities and limitations
- Analog/Digital/RF components trade-off

Channel and Interference

- Multiple UEs/Stations
- 3D propagation channel

Investigate the impact of RF impairments

- Frequency dependency
- Non-linearities
- Mismatches and coupling

Testimony

“We need a multidomain platform for simulation, rapid prototyping, and iterative verification from the behavior model to testbed prototyping to the industrial product.

MATLAB and Simulink are helping us to achieve these goals.”

- Kevin Law, director of algorithm architecture and design, Huawei -

Can you tell us more about how MATLAB and Simulink are helping you?

These two platforms play an important role in our innovation areas like 5G, optical communication, and wireless terminals. The tools give us top-down Model-Based Design, a product ecosystem that covers multiple domains, and code generation and iterative verification.

https://www.mathworks.com/content/dam/mathworks/tag-team/Objects/h/80861v00_Huawei_QA.pdf

Standard-Compliant Waveforms

Standard compliance

- Generate all physical channels and signals

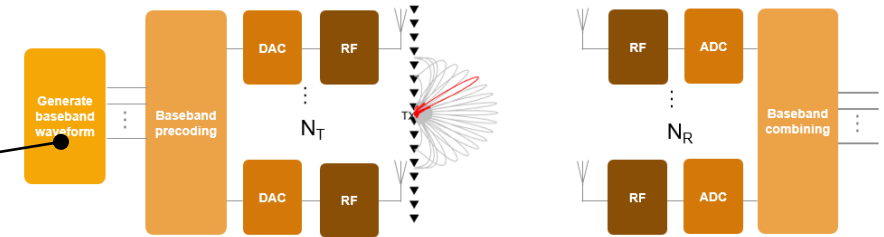

- Full custom and off-the-shelf waveforms

LTE System Toolbox

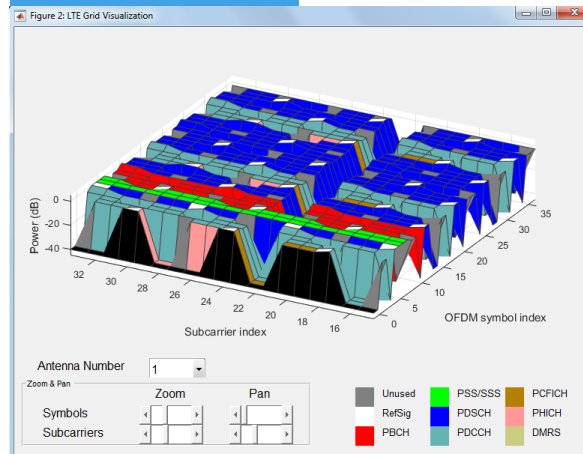

5G Library

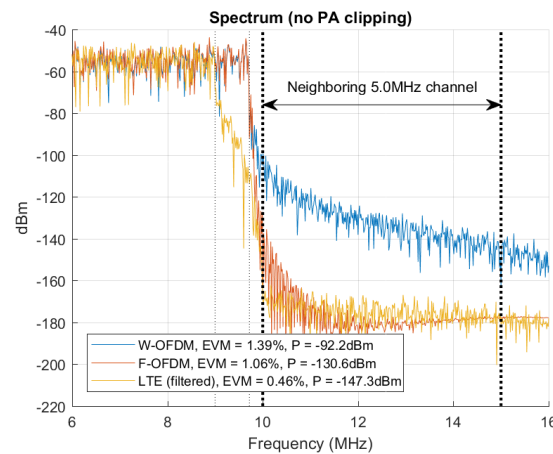

WLAN System Toolbox

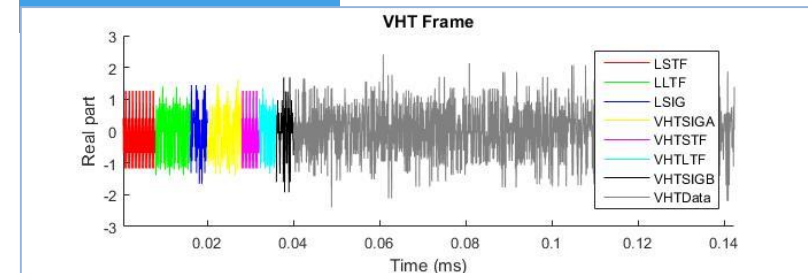

Standard-Compliant Waveforms

- Main standards offered:

IEEE 802.11

- ✓ 802.11ad
- ✓ 802.11ah
- ✓ 802.11ac
- ✓ 802.11a/b/g/n
- ✓ 802.11p/j

3GPP

- ✓ LTE & LTE-Advanced
- ✓ NB-IoT
- ✓ D2D Sidelink
- ✓ V2X Sidelink
- ✓ 5G New Radio

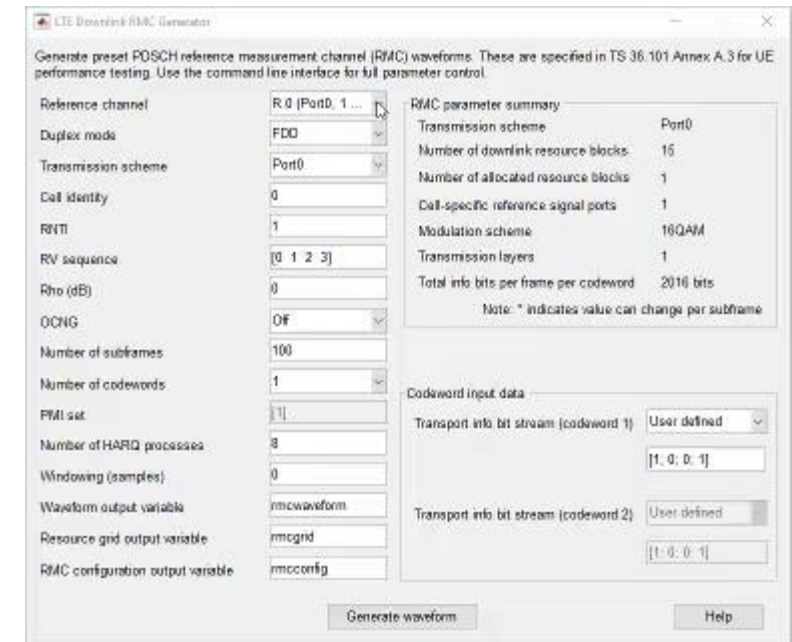

Baseband DSP Development

Baseband DSP development

- DSP challenges due to large bandwidths
- Is my implementation correct?
- How can I evaluate link performance with my algorithm?

• 5G waveforms

- F-OFDM = Filtered OFDM
- W-OFDM = Windowed OFDM
- CP-OFDM = Cyclic-Prefix OFDM

• Wideband signals

- Variable subcarrier spacing: 15,30,60,120,240kHz

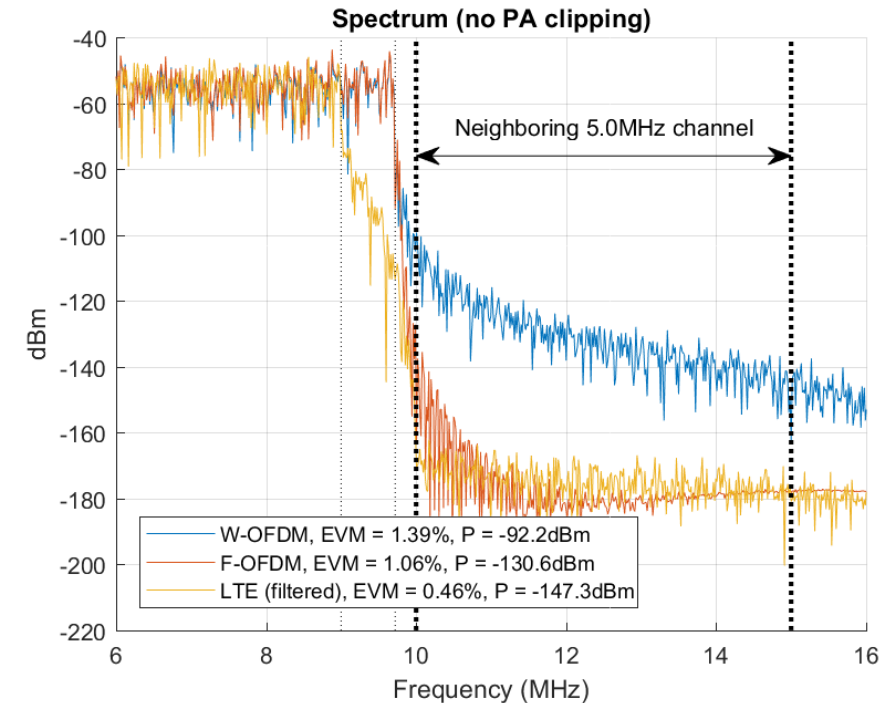
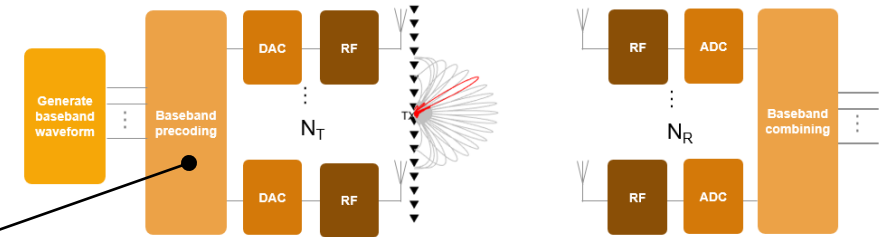

Baseband DSP Development

- LDPC code for user data channels

- Flexible for all block sizes
- Memoryless Block Coding

- Polar codes for control channels

- Capacity achieving as opposed to just capacity approaching.
- CRC-aided Successive Cancellation List Decoding (CA-SCL)
- Downlink and uplink control information (DCI/UCI) and PBCH

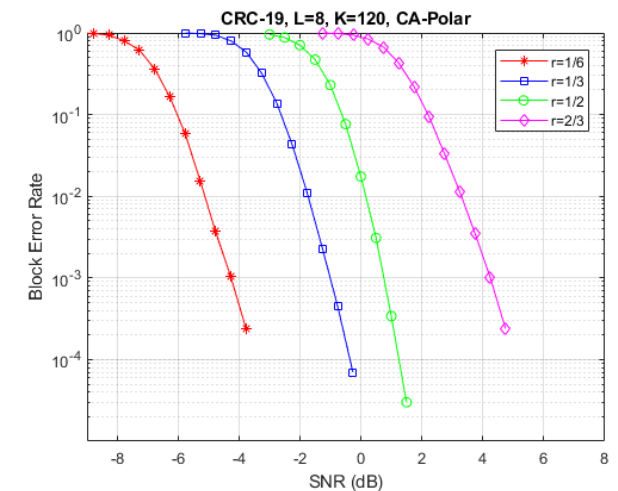
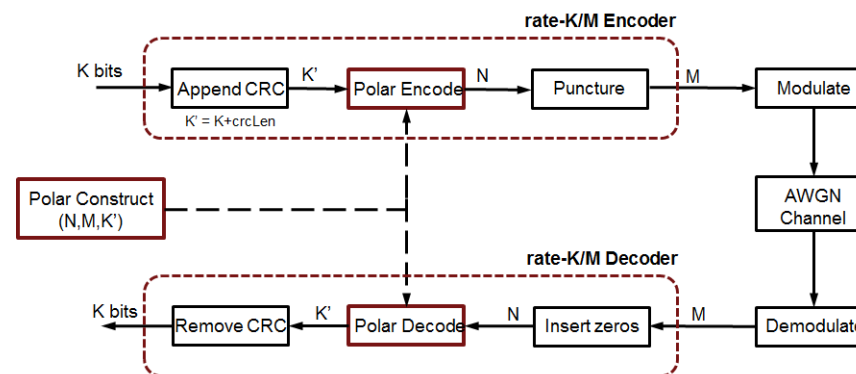
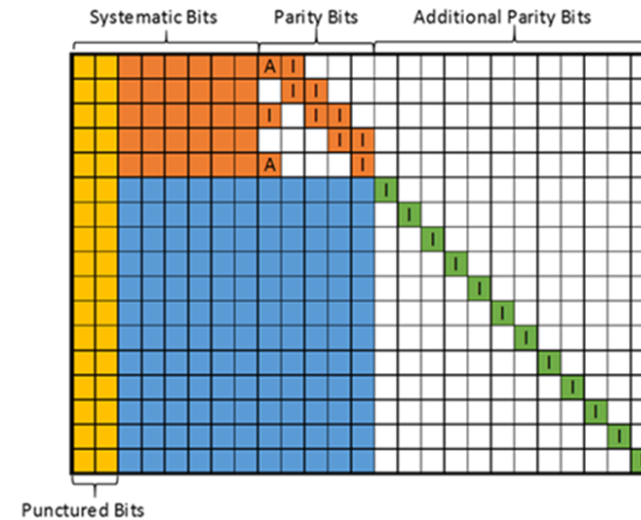

Channel and Interference

Channel and Interference

- Multiple UEs/Stations
- 3D propagation channel

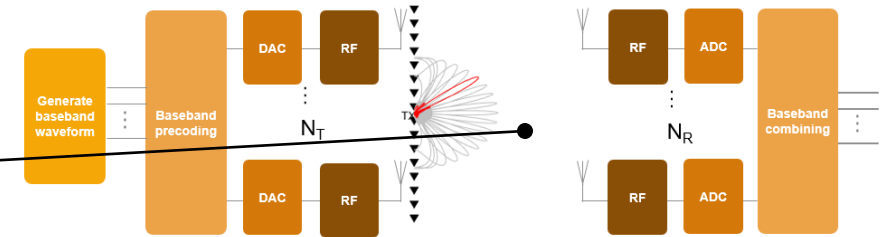

- Interference
 - Multiple standards: LTE/WLAN
 - Multi-cell / Multiple UEs
- Propagation channels
 - LTE
 - 5G
 - Custom

LTE WLAN

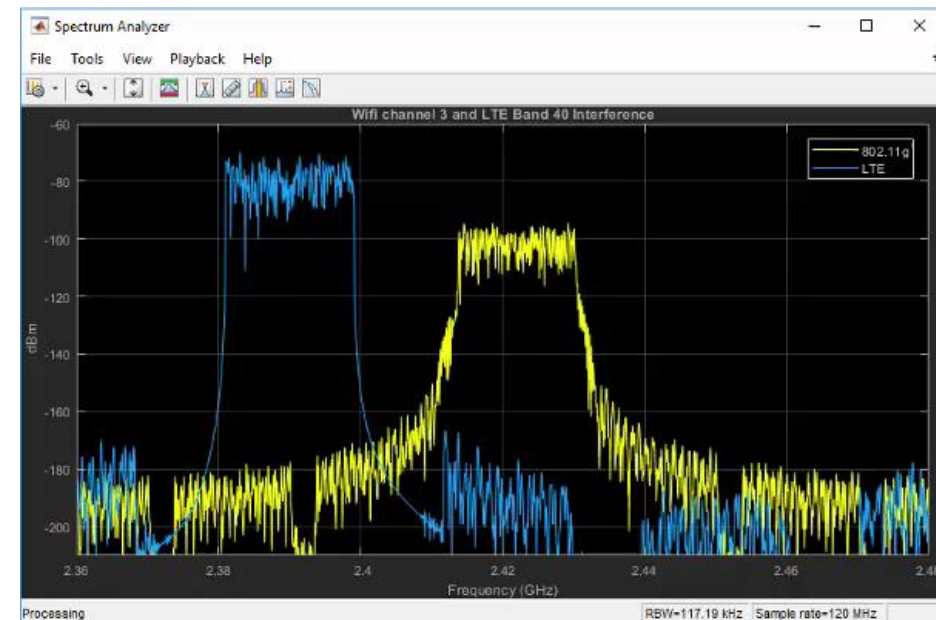

Channel and Interference

- 5G channel models TR 38.901: 0.5 - 100 GHz
- Control of:
 - Delay profile: TDL and CDL profiles: A, B, C, D, E or custom
 - Channel delay spread
 - Doppler shift
 - MIMO correlation

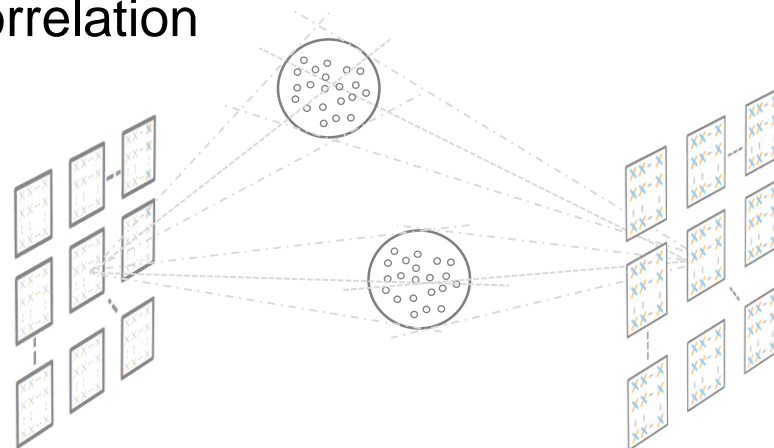
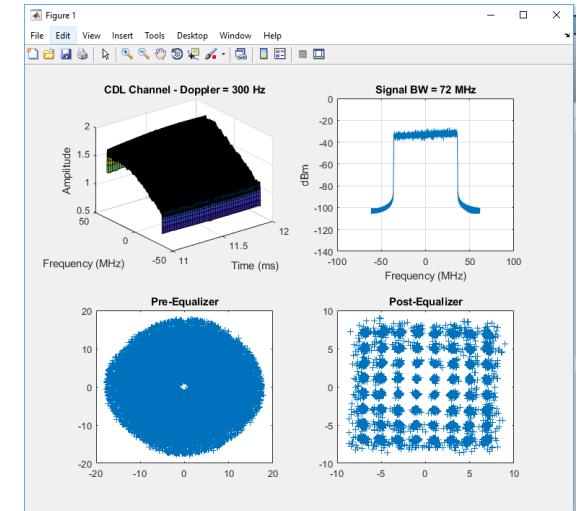

Cluster Delay Line: 3D model

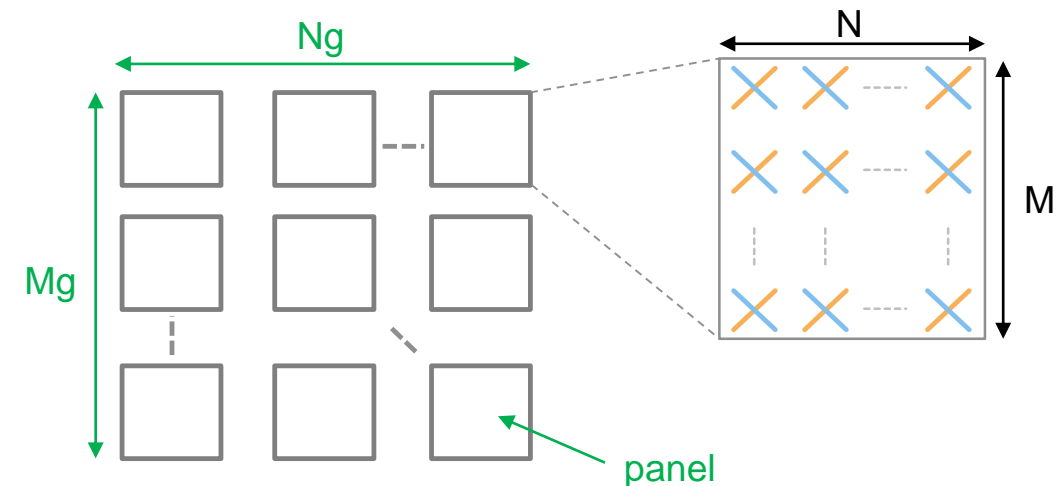

Antenna Array Design and Evaluation

Antenna array design and evaluation

- Element coupling
- Edge effects
- Imperfections

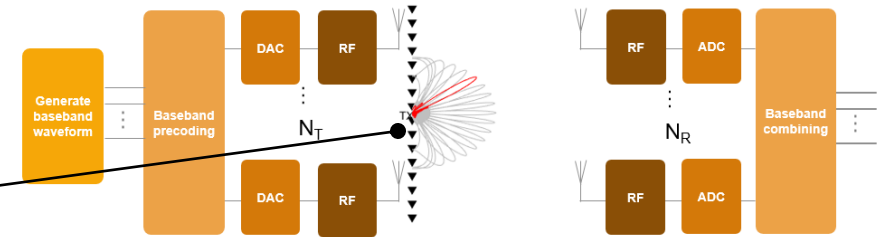

Design custom elements

- Predefined or custom shape
- Polarization support

Dipole

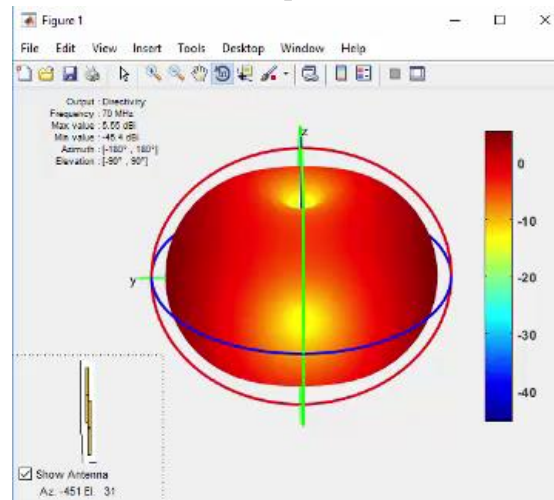

Inverted F

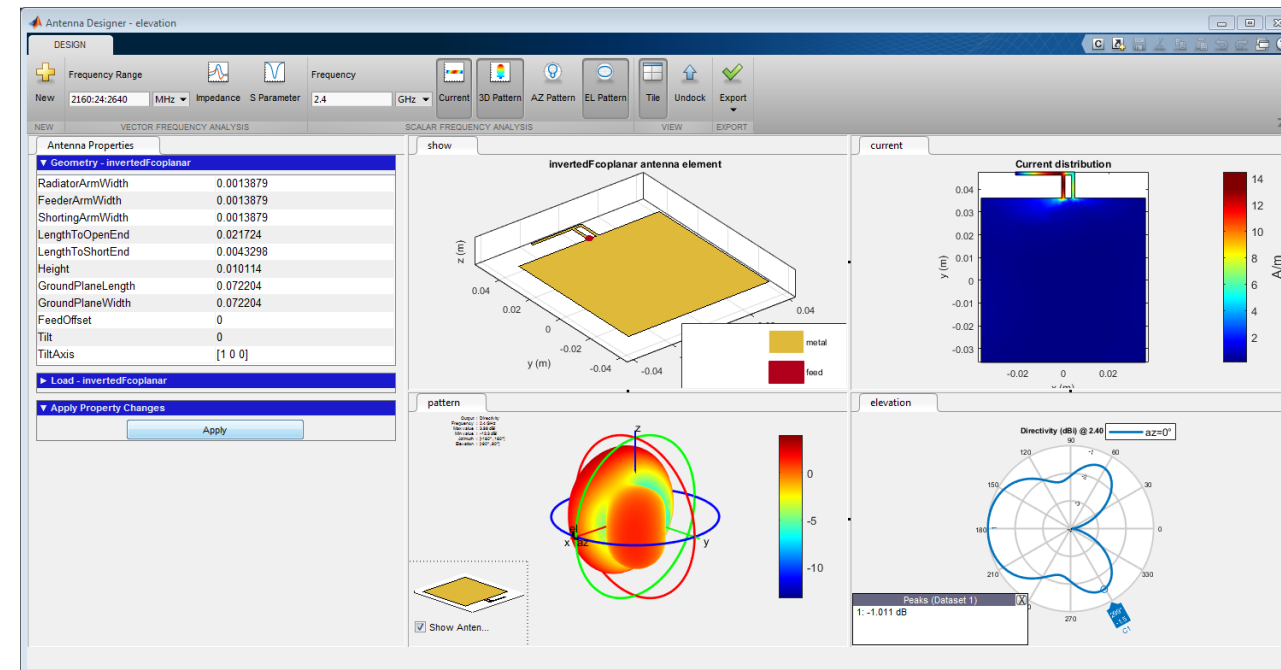

Antenna Array Design and Evaluation

- Advanced algorithms and imperfection mitigation
 - For ULA, URA, conformal arrays

Design 32x32 Array

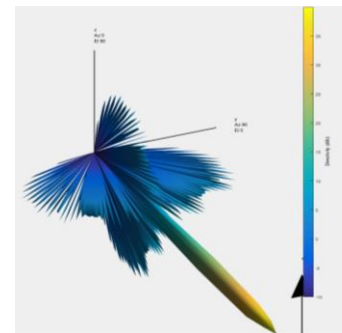
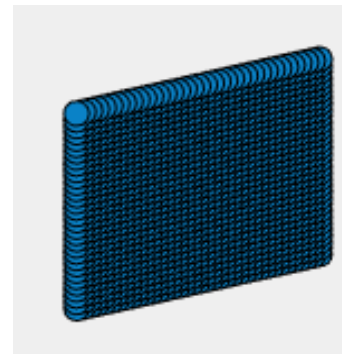

Calibration

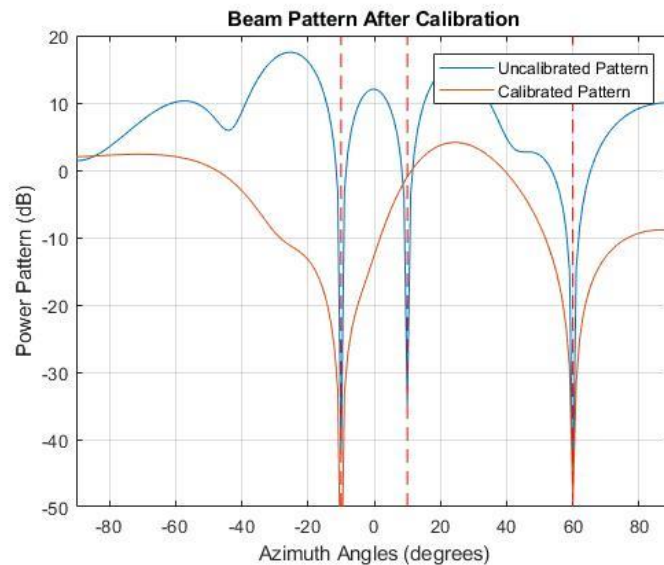

Direction of Arrival

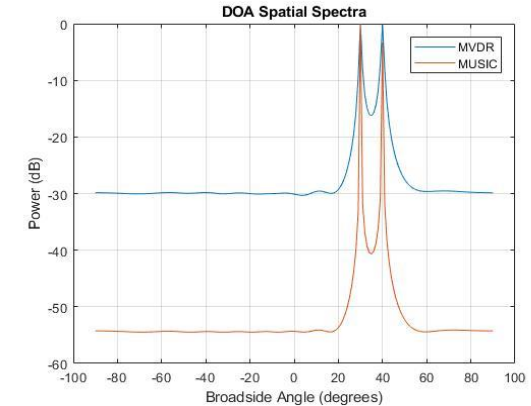

Mutual Coupling

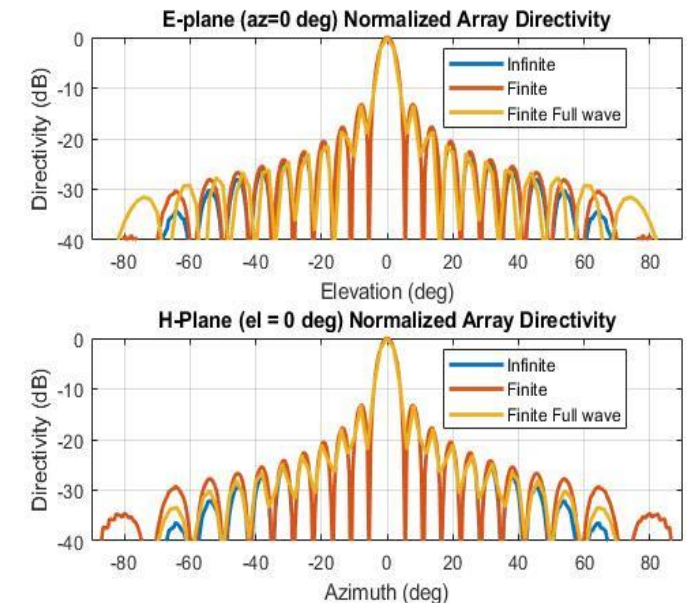

Explore Beamforming Trade-Offs

Explore beamforming trade-offs

- Baseband, analog or hybrid beamforming?
- Simulate capabilities and limitations
- Analog/Digital/RF components trade-off

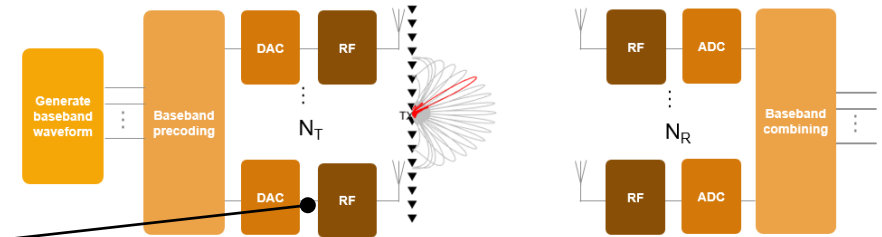

- Generate steering vectors
- Place null in direction of interferer

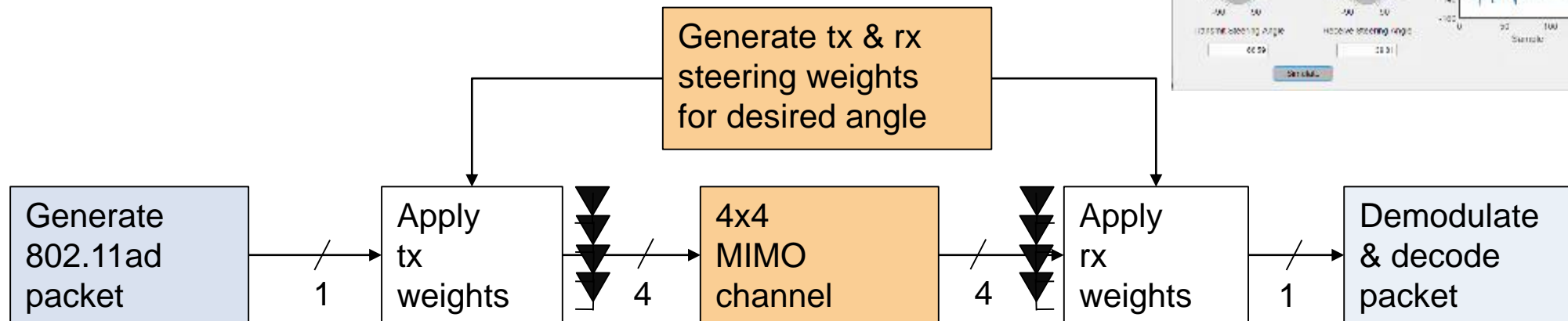
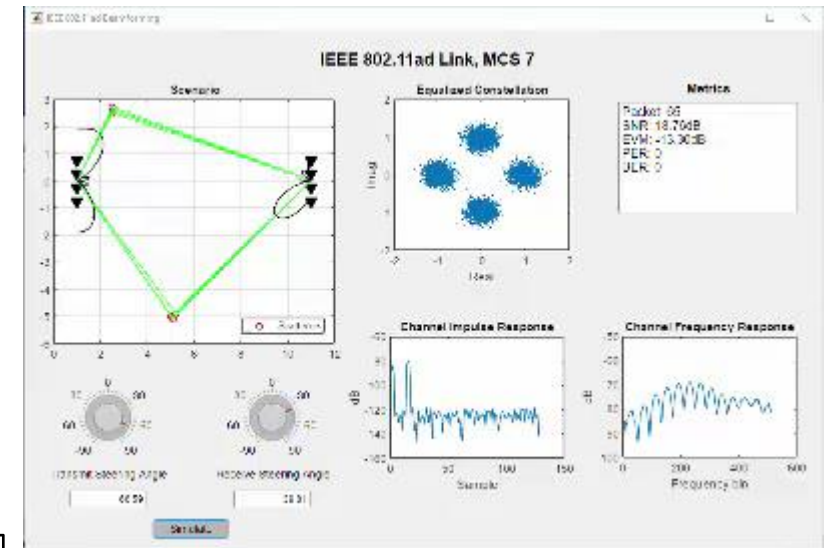

Explore Beamforming Trade-Offs

- Hybrid beamforming
 - Phase resolution
 - DAC/ADC resolution
 - Trade-off performance, power dissipation, implementation complexity

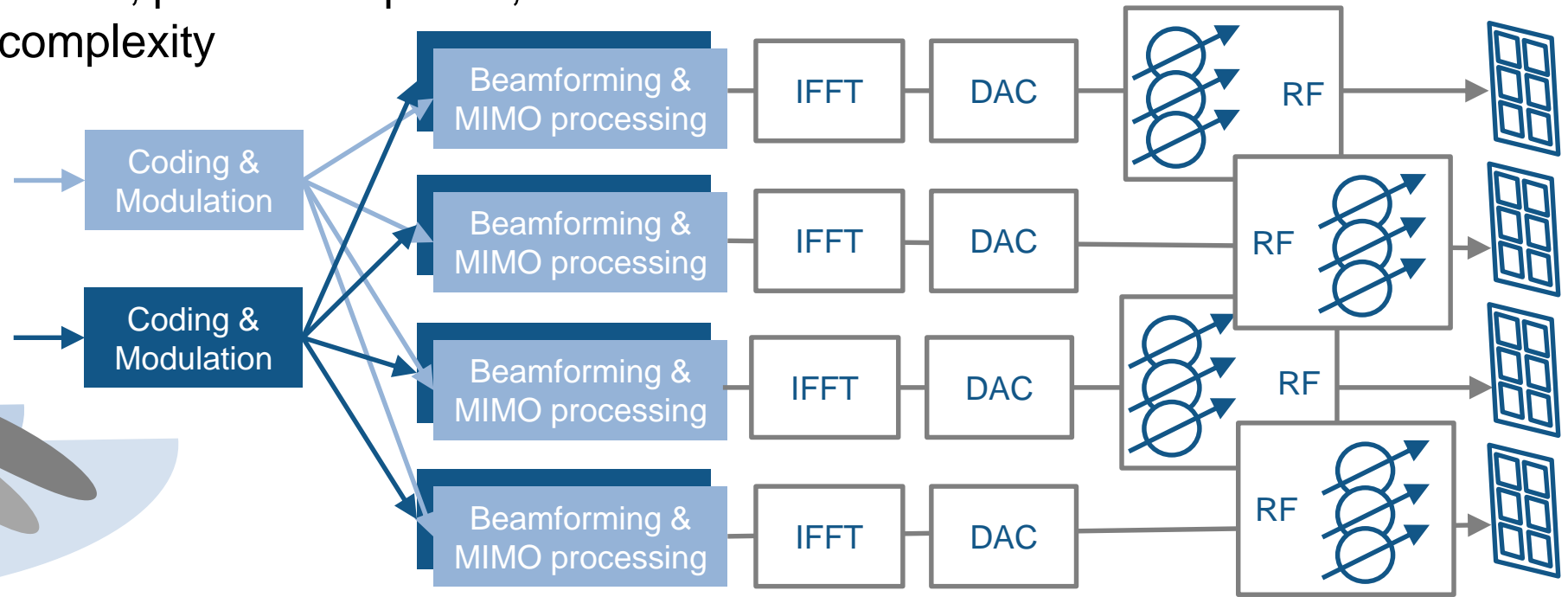
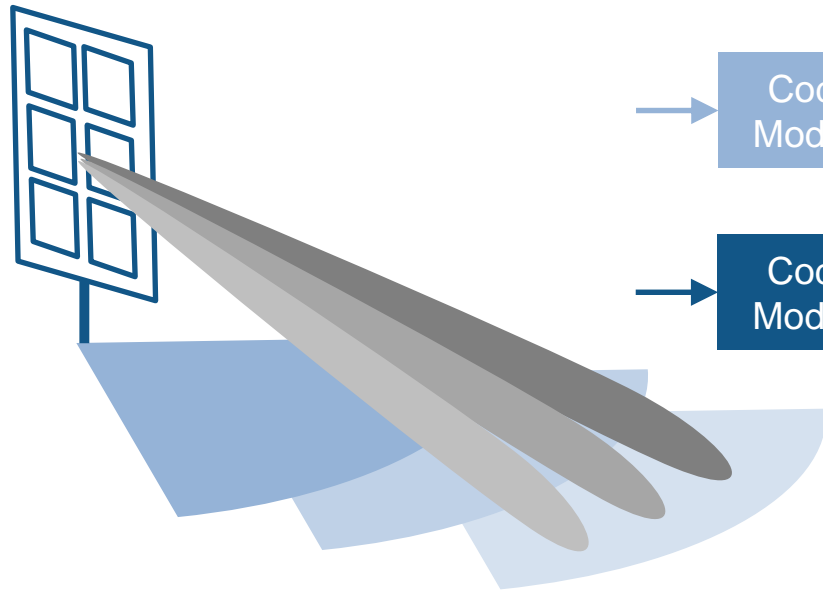

Investigate the Impact of RF Impairments

Investigate the impact of RF impairments

- Frequency dependency
- Non-linearities
- Mismatches and coupling

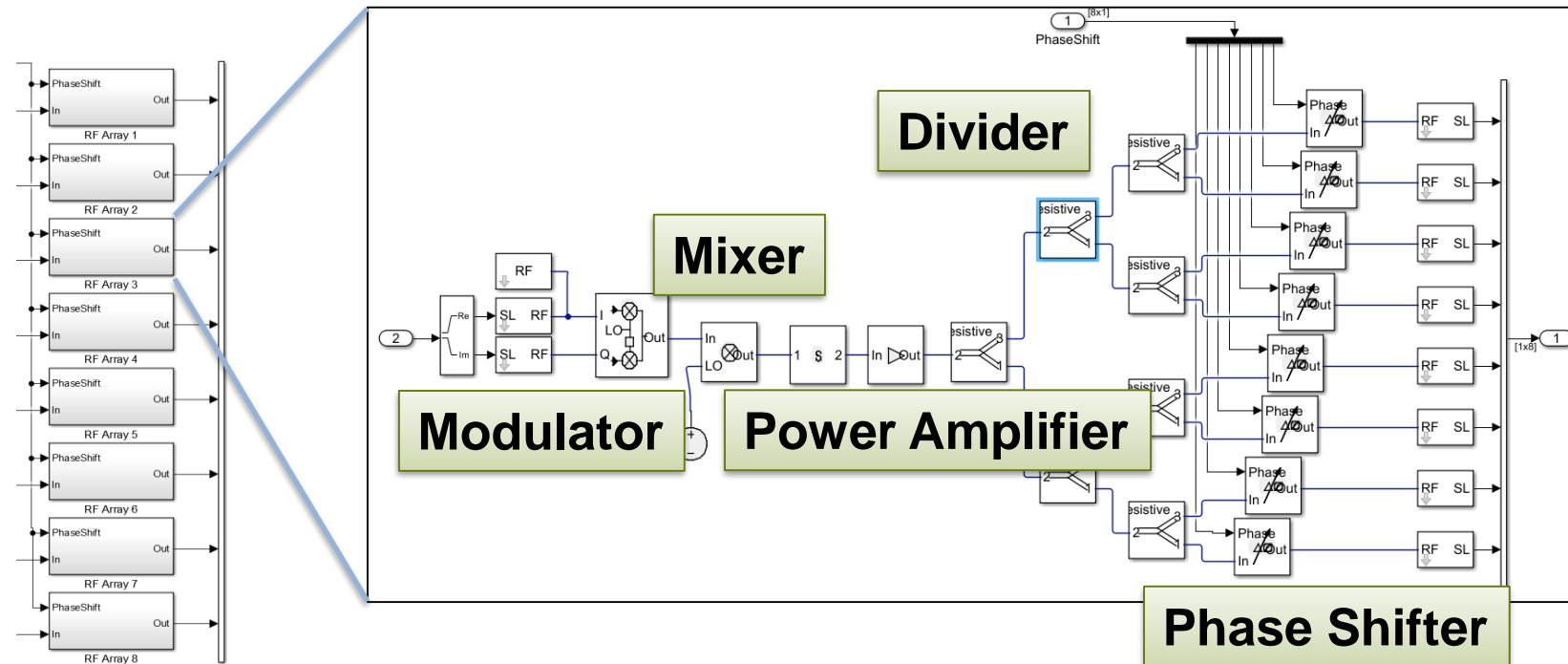
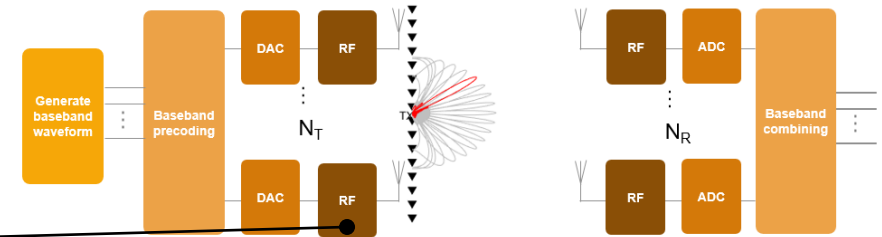

Investigate the Impact of RF Impairments

- Non-linear amplifier with memory
- S-Parameters
- Intermodulation distortion

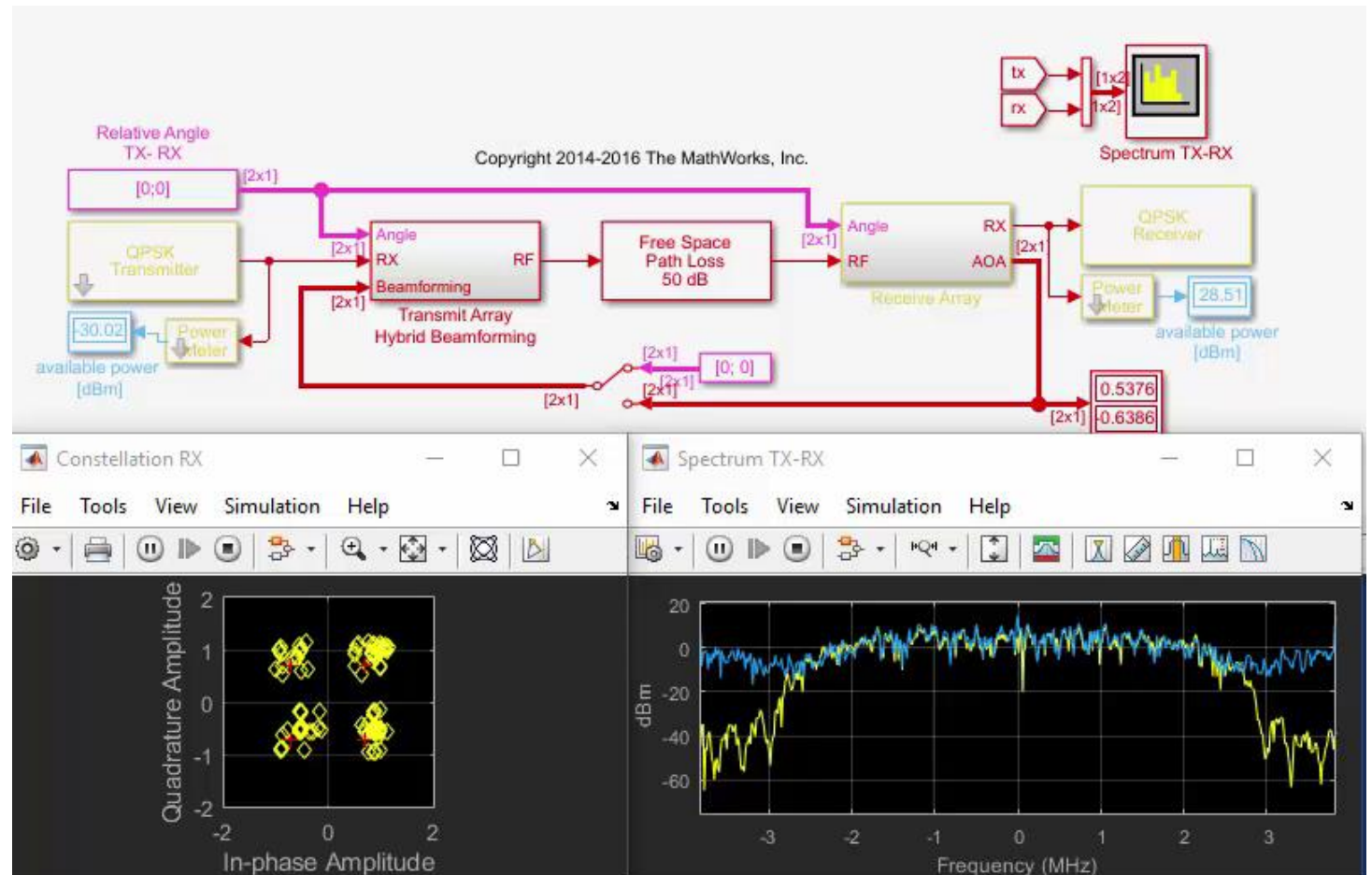

Products of Interest

LTE System Toolbox

WLAN System Toolbox

Antenna Toolbox

Phased Array System Toolbox

RF Blockset

Communications System Toolbox

Addressing Wireless Engineering Challenges

Generate baseband waveform

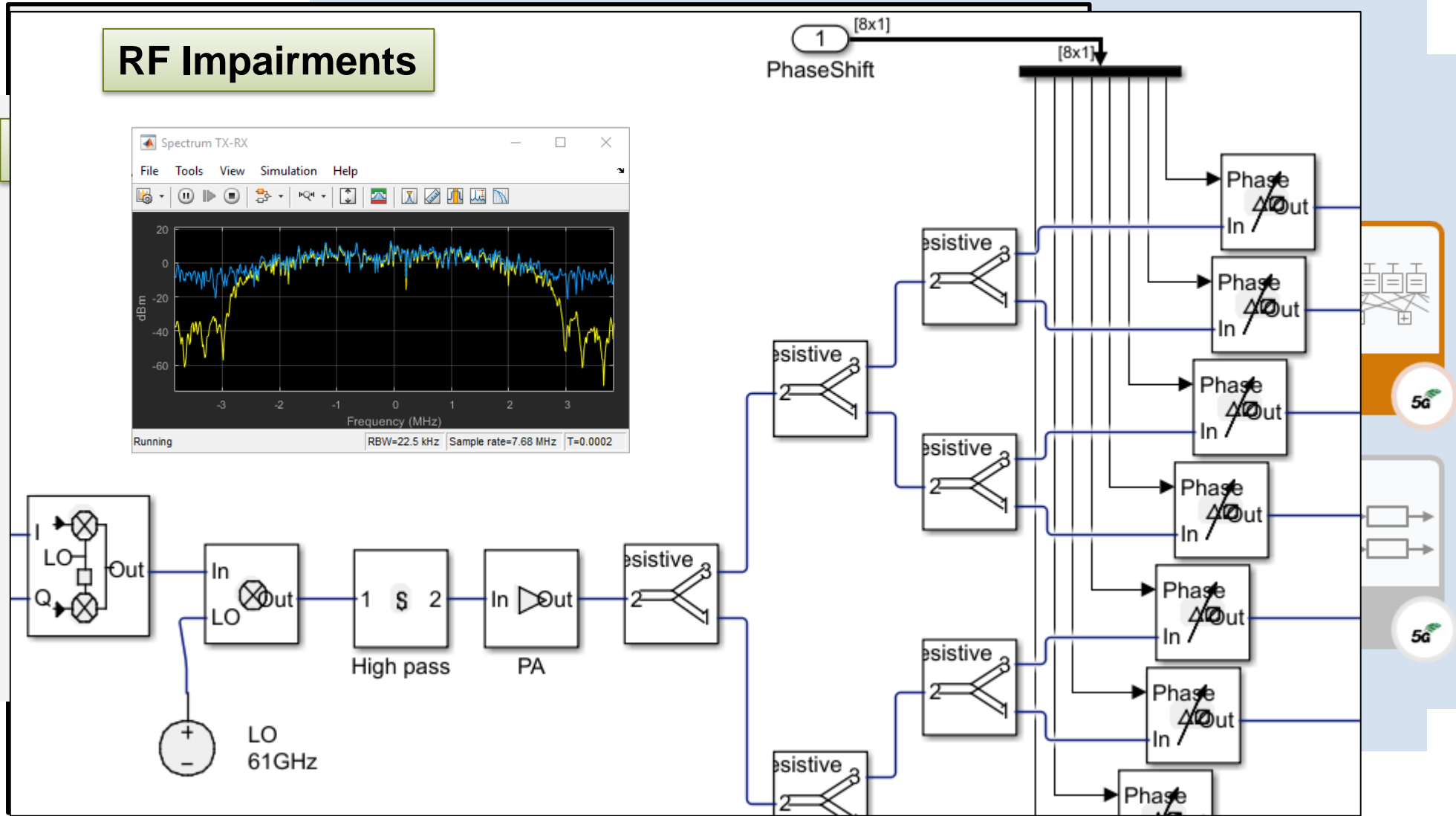

Resources – Links in PDF Document

- [MATLAB and Simulink for 5G Technology Development](#)
- [Download the 5G Library](#)
- [Introduction to 5G Library](#) (4:54 video)
- [Evaluating 5G Waveforms Over 3D Propagation Channels with the 5G Library](#) (white paper)
- [Wireless Suite](#) (US only): package set of 10 wireless products
- [Hybrid Beamforming for Massive MIMO Phased Array Systems](#) (white paper)
- [LTE System Toolbox](#)
- [WLAN System Toolbox](#)

Thank You!